

Product data sheet

Specifications



Motor circuit breaker, TeSys Deca frame 2, 3P, 14A, magnetic, rotary handle, screw clamp terminals

GV2L16

Main

Range	TeSys Deca
product name	TeSys GV2
Product or component type	Motor circuit breaker
Device short name	GV2L
Device application	Motor protection
Trip unit technology	Magnetic

Complementary

Poles description	3P
network type	AC
Utilisation category	Category A conforming to IEC 60947-2 AC-3 conforming to IEC 60947-4-1 AC-3e conforming to IEC 60947-4-1
Network frequency	50/60 Hz conforming to IEC 60947-2
Motor power kW	5.5 kW at 400/415 V AC 50/60 Hz 7.5 kW at 500 V AC 50/60 Hz 9 kW at 690 V AC 50/60 Hz 11 kW at 690 V AC 50/60 Hz
Breaking capacity	100 kA Icu at 230/240 V AC 50/60 Hz conforming to IEC 60947-2 50 kA Icu at 400/415 V AC 50/60 Hz conforming to IEC 60947-2 20 kA Icu at 440 V AC 50/60 Hz conforming to IEC 60947-2 10 kA Icu at 500 V AC 50/60 Hz conforming to IEC 60947-2 4 kA Icu at 690 V AC 50/60 Hz conforming to IEC 60947-2
[Ics] rated service short-circuit breaking capacity	100 % at 230/240 V AC 50/60 Hz conforming to IEC 60947-2 50 % at 400/415 V AC 50/60 Hz conforming to IEC 60947-2 75 % at 440 V AC 50/60 Hz conforming to IEC 60947-2 75 % at 500 V AC 50/60 Hz conforming to IEC 60947-2 100 % at 690 V AC 50/60 Hz conforming to IEC 60947-2
Control type	Rotary handle
[In] rated current	14 A
Magnetic tripping current	253.4 A
[Ith] conventional free air thermal current	14 A conforming to IEC 60947-4-1
[Ue] rated operational voltage	690 V AC 50/60 Hz conforming to IEC 60947-2
[Ui] rated insulation voltage	690 V AC 50/60 Hz conforming to IEC 60947-2
[Uimp] rated impulse withstand voltage	6 kV conforming to IEC 60947-2
Suitability for isolation	Yes conforming to IEC 60947-1
Power dissipation per pole	1.8 W

Mechanical durability	100000 cycles
Electrical durability	100000 cycles for AC-3 at 415 V In 100000 cycles for AC-3e at 415 V In
Rated duty	Continuous conforming to IEC 60947-4-1
Tightening torque	1.7 N.m - on screw clamp terminal
Fixing mode	35 mm symmetrical DIN rail: clipped Panel: screwed (with 2 x M4 screws)
Mounting position	Horizontal Vertical
Width	45 mm
Height	89 mm
Depth	97 mm
Product weight	0.33 kg
Colour	Dark grey

Environment

Standards	EN/IEC 60947-2 EN/IEC 60947-4-1 UL 60947-4-1 CSA C22.2 No 60947-4-1 IEC/EN 60335-2-40:Annex JJ
Product certifications	CCC UL CSA EAC LROS (Lloyds register of shipping) BV RINA DNV-GL UKCA IECEE CB Scheme
IK degree of protection	IK04
IP degree of protection	IP20 conforming to IEC 60529
Climatic withstand	conforming to IACS E10
Ambient air temperature for storage	-40...80 °C
Fire resistance	960 °C conforming to IEC 60695-2-11
Ambient air temperature for operation	-20...60 °C
Mechanical robustness	Shocks: 30 Gn for 11 ms Vibrations: 5 Gn, 5...150 Hz
Operating altitude	2000 m

Packing Units

Unit Type of Package 1	PCE
Number of Units in Package 1	1
Package 1 Height	9.500 cm
Package 1 Width	10.000 cm
Package 1 Length	5.000 cm
Package 1 Weight	322.000 g
Unit Type of Package 2	S02

Number of Units in Package 2	20
Package 2 Height	15.000 cm
Package 2 Width	30.000 cm
Package 2 Length	40.000 cm
Package 2 Weight	6.774 kg

Contractual warranty

Warranty	18 months
-----------------	-----------



Environmental Data

Schneider Electric aims to achieve Net Zero status by 2050 through supply chain partnerships, lower impact materials, and circularity via our ongoing “Use Better, Use Longer, Use Again” campaign to extend product lifetimes and recyclability.

[Environmental Data explained >](#)

[How we assess product sustainability >](#)

Environmental footprint

Carbon footprint (kg.eq.CO2 per CR, Total Life cycle) **8**

Environmental Disclosure [Product Environmental Profile](#)

Use Better

Materials and Substances

Packaging made with recycled cardboard **No**

Packaging without single use plastic **No**

SCIP Number **04104e70-ba29-493c-b2cc-b5837d1f879b**

China RoHS Regulation [China RoHS declaration](#)

Use Again

Repack and remanufacture

Circularity Profile [End of Life Information](#)

WEEE  The product must be disposed on European Union markets following specific waste collection and never end up in rubbish bins

Take-back **No**

Performance Curves

Tripping Curves for GV2L or LE Combined with Thermal Overload Relay LRD or LR2K
 Average Operating Times at 20 °C Related to Multiples of the Setting Current

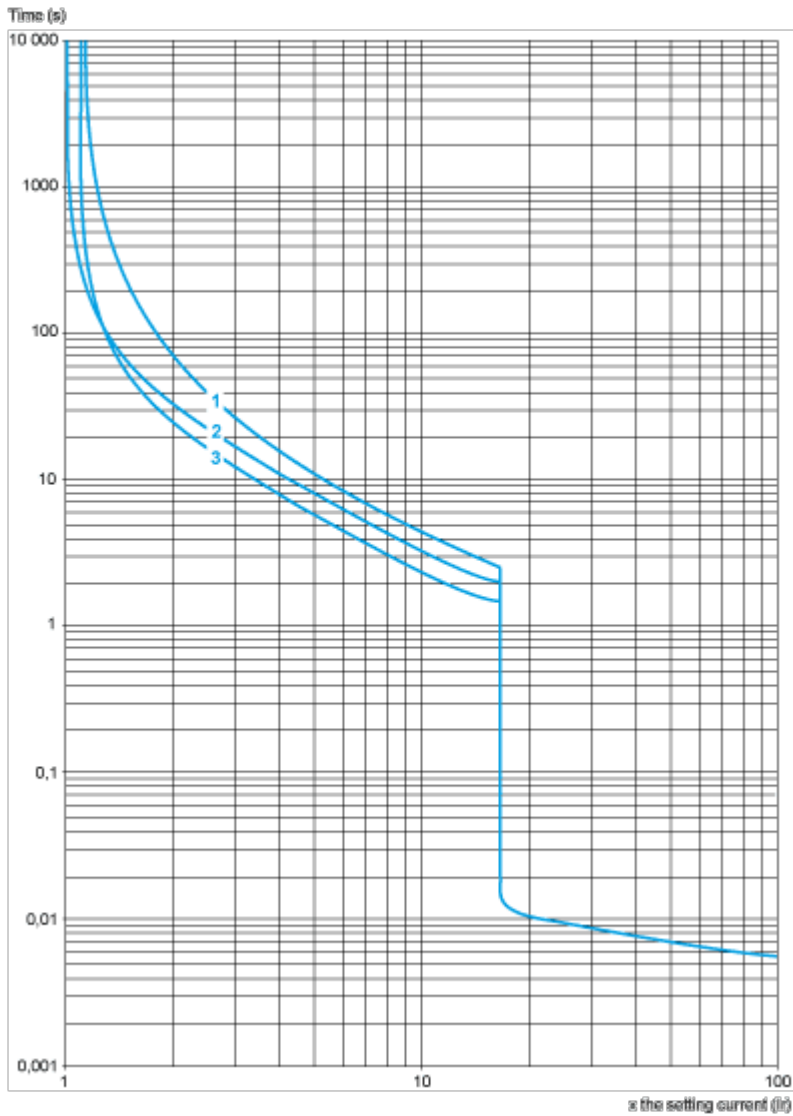

- 1 3 poles from cold state
- 2 2 poles from cold state
- 3 3 poles from hot state

Current Limitation on Short-Circuit for GV2L and GV2LE Only (3-Phase 400/415 V)

Dynamic Stress

$I_{peak} = f(\text{prospective } I_{sc}) \text{ at } 1.05 U_e = 435 \text{ V}$

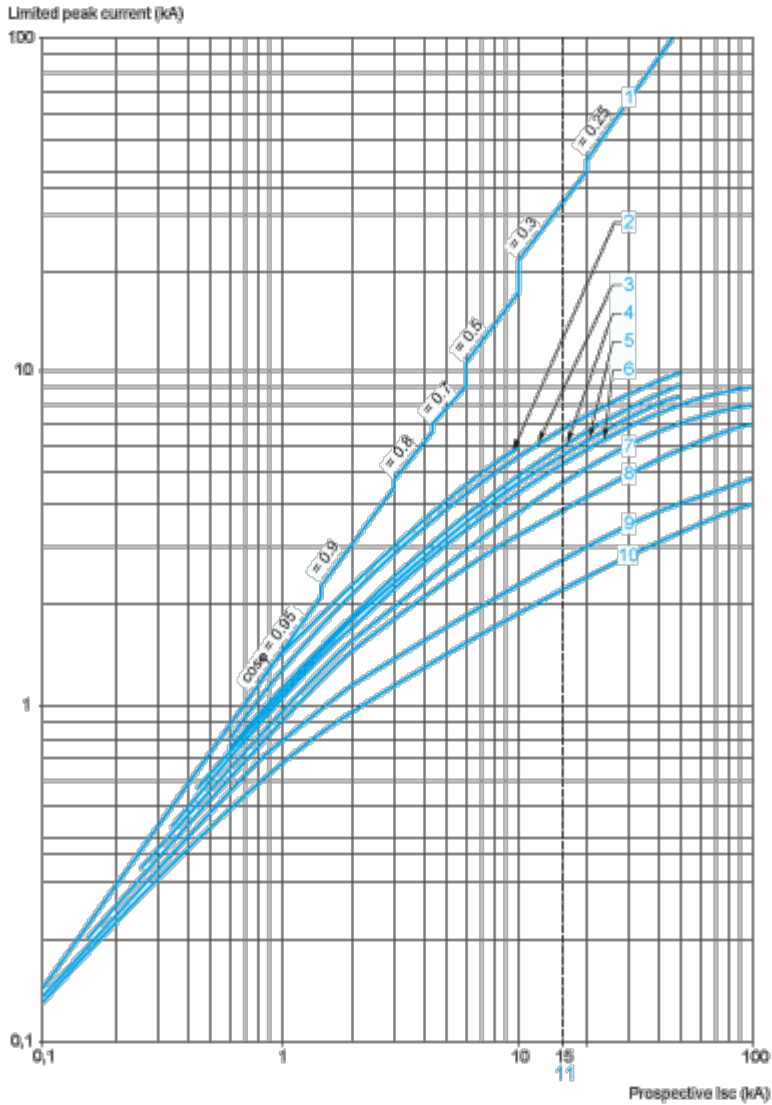

- 1 Maximum peak current
- 2 32 A
- 3 25 A
- 4 18 A
- 5 14 A
- 6 10 A
- 7 6.3 A
- 8 4 A
- 9 2.5 A
- 10 1.6 A
- 11 Limit of rated ultimate breaking capacity on short-circuit of GV2LE (14, 18, 23, and 25 A ratings).

Current Limitation on Short-Circuit for GV2L and GV2LE + Thermal Overload Relay LRD or LR2K (3-Phase 400/415 V)

Dynamic Stress

$I_{peak} = f(\text{prospective } I_{sc})$ at $1.05 U_e = 435 V$

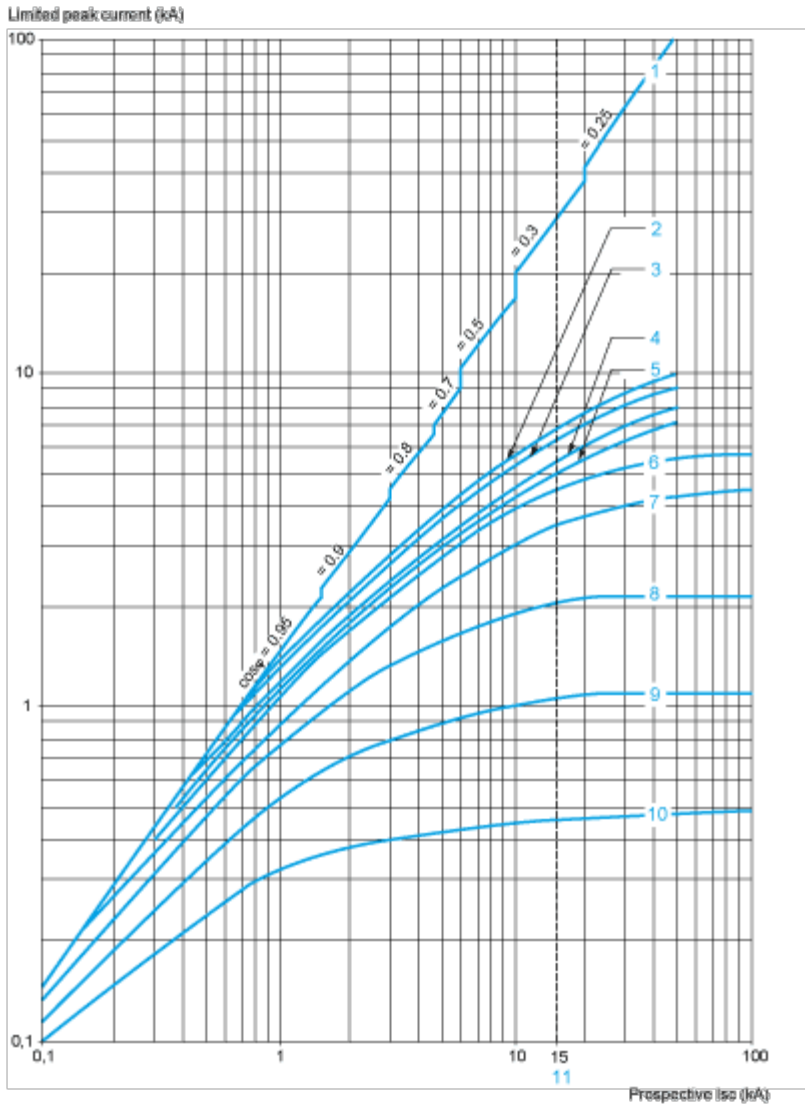

- 1 Maximum peak current
- 2 32 A
- 3 25 A
- 4 18 A
- 5 14 A
- 6 10 A
- 7 6.3 A
- 8 4 A
- 9 2.5 A
- 10 1.6 A
- 11 Limit of rated ultimate breaking capacity on short-circuit of GV2LE (14, 18, 23, and 25 A ratings).

Thermal Limit on Short-Circuit for GV2L Only

Thermal Limit in kA²s in the Magnetic Operating Zone

Sum of I²dt = f (prospective Isc) at 1.05 Ue = 435 V

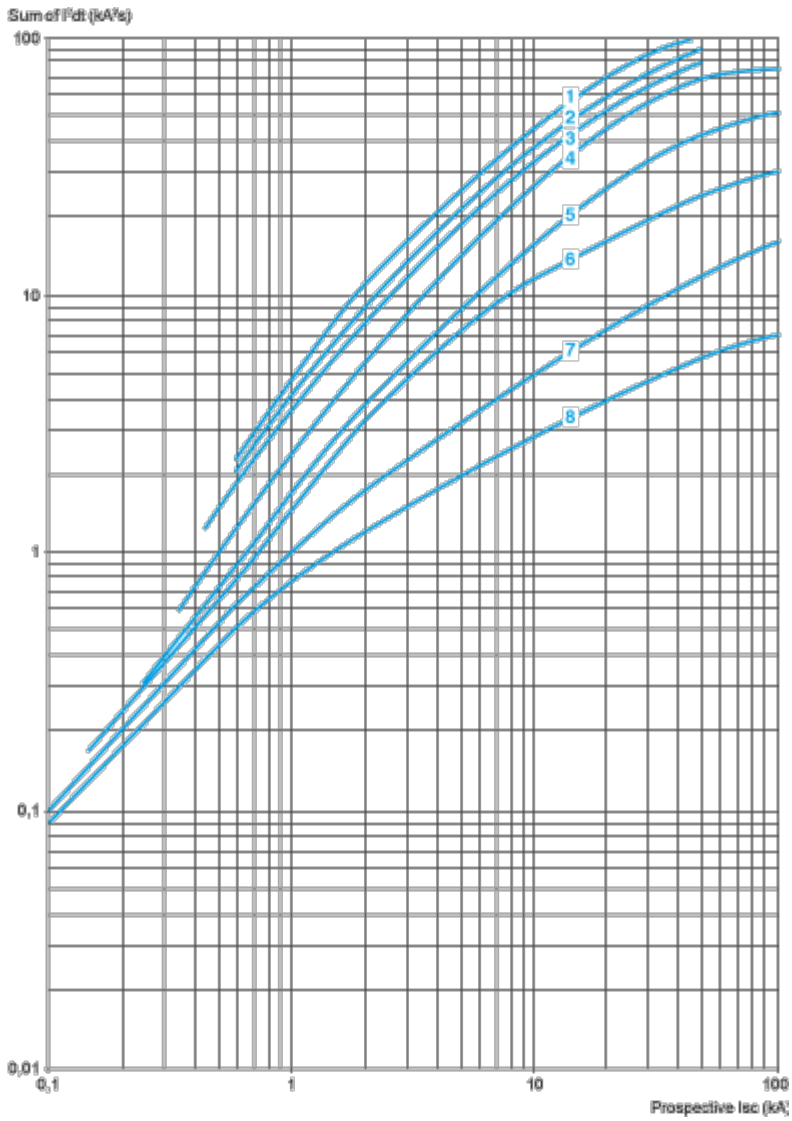

- 1 25 A and 32 A
- 2 18 A
- 3 14 A
- 4 10 A
- 5 6.3 A
- 6 4 A
- 7 2.5 A
- 8 1.6 A

Thermal Limit on Short-Circuit for GV2L and GV2LE + Thermal Overload Relay LRD or LR2K

Thermal Limit in kA²s in the Magnetic Operating Zone

Sum of I²dt = f (prospective Isc) at 1.05 Ue = 435 V

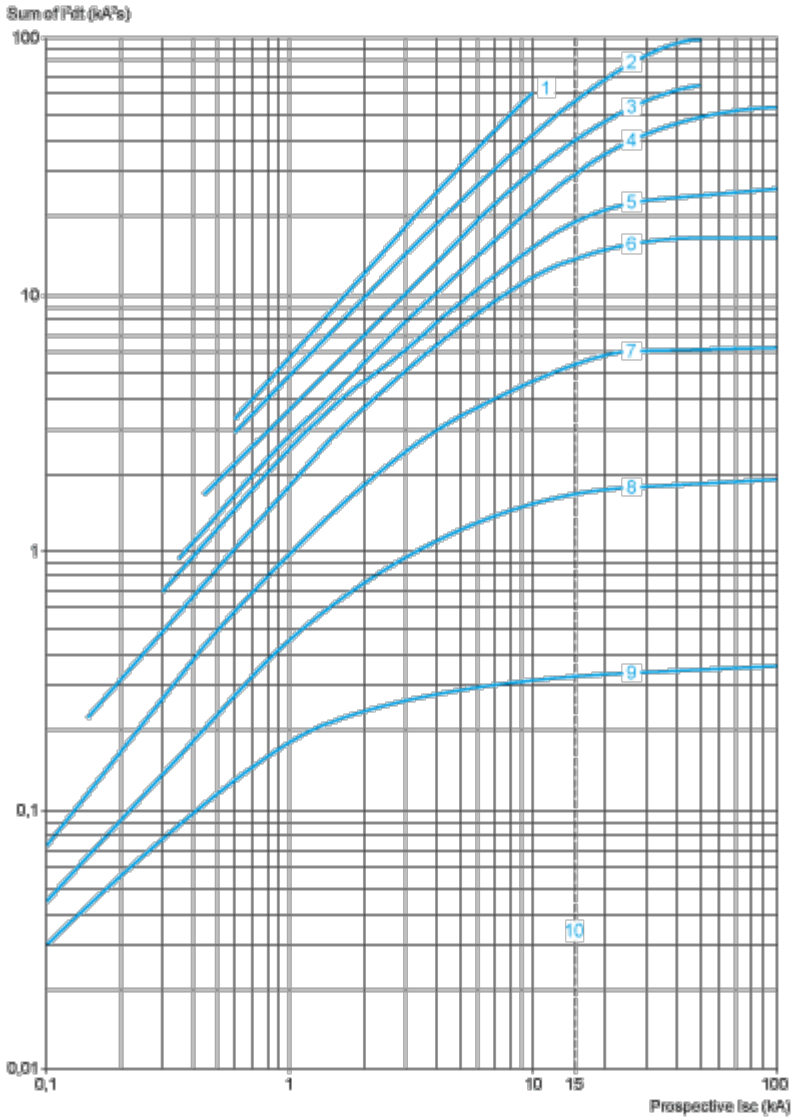

- 1 32 A (GV2LE32)
- 2 25 A and 32 A (GV2L32)
- 3 18 A
- 4 14 A
- 5 10 A
- 6 6.3 A
- 7 4 A
- 8 2.5 A
- 9 1.6 A
- 10 Limit of rated ultimate breaking capacity on short-circuit of GV2 LE (14, 18, 23, and 25 A ratings).

Dimensions Drawings

GV2L

Dimensions

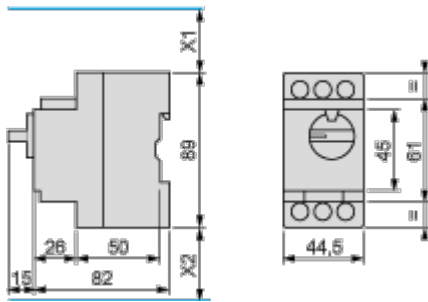

X1 Electrical clearance = 40 mm for $U_e \leq 415$ V, or 80 mm for $U_e = 440$ V, or 120 mm for $U_e = 500$ and 690 V.
 X2 = 40 mm.

GVAD, AM, AN, AU, AS

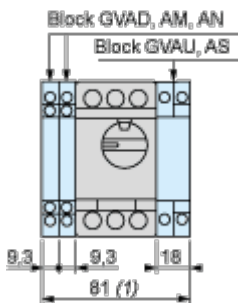

1 Maximum

GV2AK00

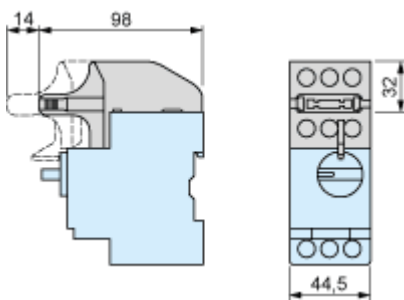

Mounting

On rail AM1 DE200, AM1 ED200 (35 x 15)

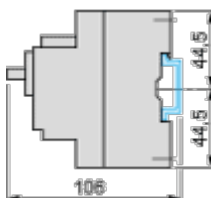

Panel mounted

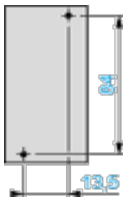

On pre-slotted mounting plate AM1 PA

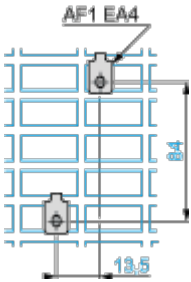

Adapter Plate GK2AF01

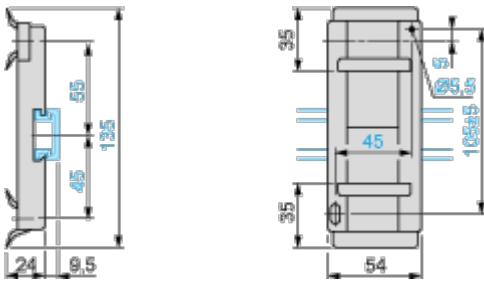

7.5 mm Height Compensation Plate GV1F03

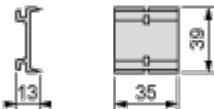

Mounting

Mounting of External Operator GV2APN01, GV2APN02 or GV2APN04 for Motor Circuit Breakers GV2L

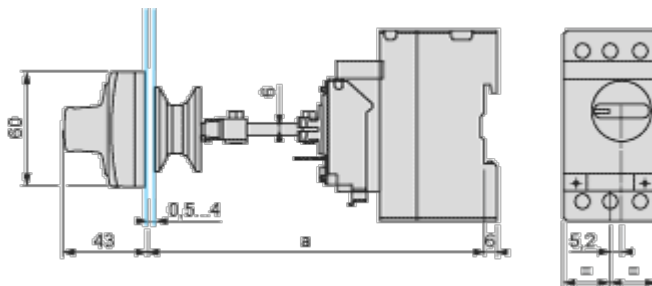

Door cut-out

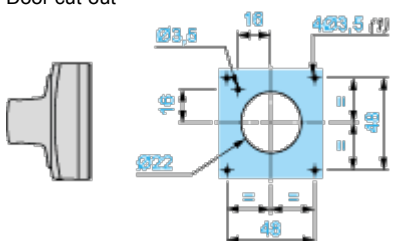

(1) For IP65 only.

Mounting of External Operator GVAPH02 for Motor Circuit Breakers GV2L

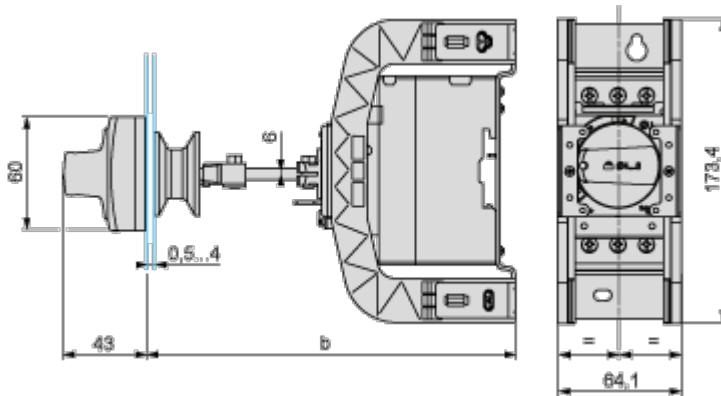

	b	
	Minimum	Maximum
GV2 APN _{..} + GV APH02	151	250
GV2 APN _{..} + GV APH02 + GV APK11	250	445

Door cut-out

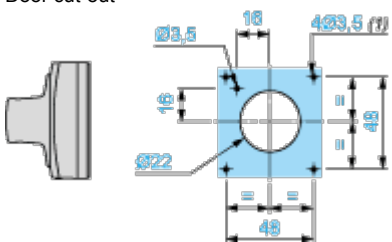

(1) For IP65 only.

GV2L and GV2LE

Sets of busbars GV2G445, GV2G454, GV2G472, with terminal block GV2G05

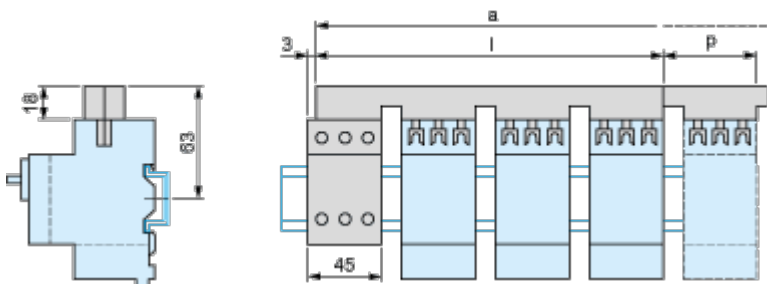

	l	p
GV2G445 (4 x 45 mm)	179	45
GV2G454 (4 x 54 mm)	206	54
GV2G472 (4 x 72 mm)	260	72

Number of tap-offs	a			
	5	6	7	8
GV2G445	224	269	314	359
GV2G454	260	314	368	422
GV2G472	332	404	476	548

Sets of Busbars for GV2L and GV2LE

Sets of busbars GV2G... with terminal block GV1G09

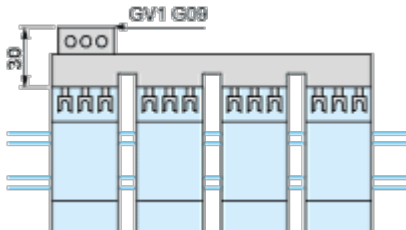

Sets of busbars GV2G245, GV2G254, GV2GR272

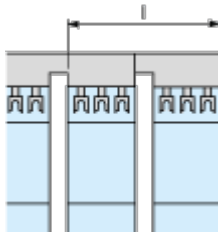

	l
GV2G245 (2 x 45 mm)	89
GV2G254 (2 x 54 mm)	98
GV2G272 (2 x 72 mm)	116

Set of busbars GV2G554

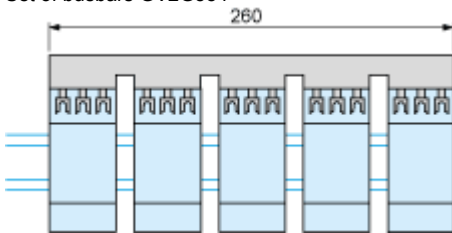

Sets of busbars GV2G345 and GV2G354

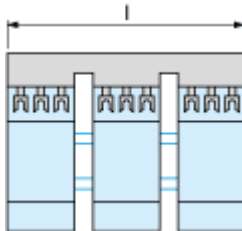

	l
GV2G345 (3 x 45 mm)	134

	I
GV2G354 (3 x 54 mm)	152

Connections and Schema

GV2L••

